

Hinge Options

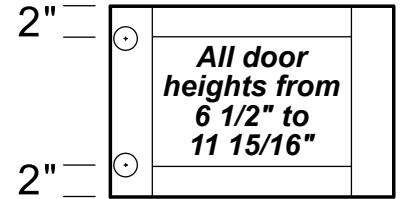
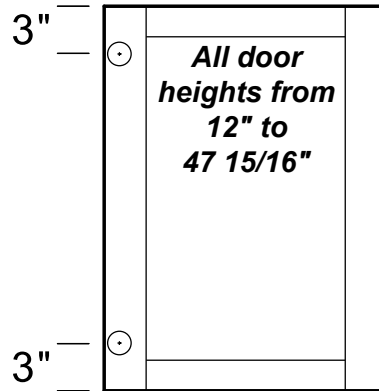
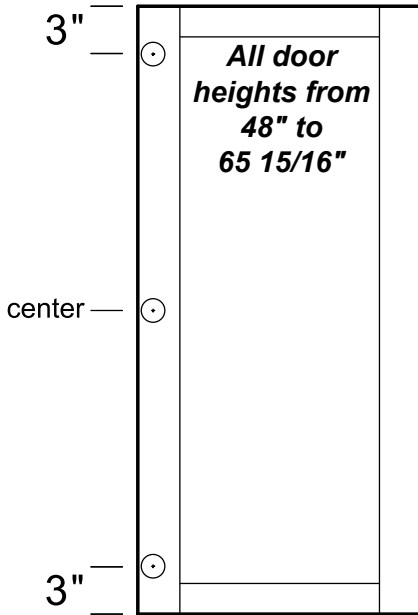

Call Customer Service for Current Pricing

Add \$x.xx per bore
For standard bore placement

Add \$x.xx per bore
For customer specified bore placement

All doors 66" and over receive four hinge bores.

Standard Hinge Boring

Cup Blum (BH), Grass (GH), European (EH): Standard distance from edge is 3mm, 1/2" deep. Hinge placement as shown above. If a custom distance from edge is needed, please inform a customer service representative. **Please check pages 14-16 to verify the compatibility of the profile and bore.**

Knife or Slot (KH): Hinge placement as shown above. Please specify width and length of slot when ordering. Standard slot specs are: 1 7/8" long; 1/16" deep and 1/32" wide.

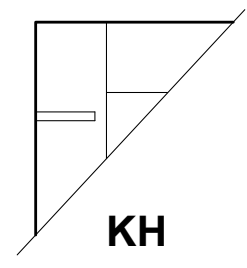
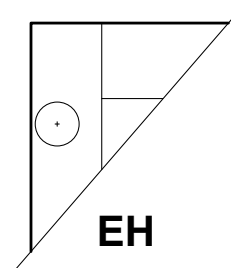
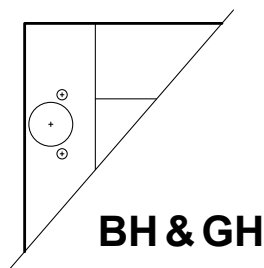

Finger Pull Options

Call Customer Service for Current Pricing
Fingerpulls are \$x.xx each

4" Fingerpulls and Locations

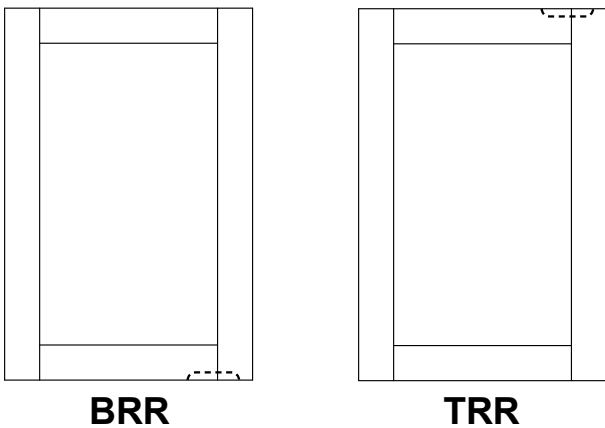

Please use abbreviations below and enter in the special notes column on order form to specify placement of 4" fingerpulls.
All pulls are viewed from the face of doors and drawer fronts.

	Right	Center	Left
Top Rail	TRR	TRC	TRL
Bottom Rail	BRR	BRC	BRL
	Top	Center	Bottom
Right Stile	RST	RSC	RSB
Left Stile	LST	LSC	LSB

Full Length Fingerpulls and Locations

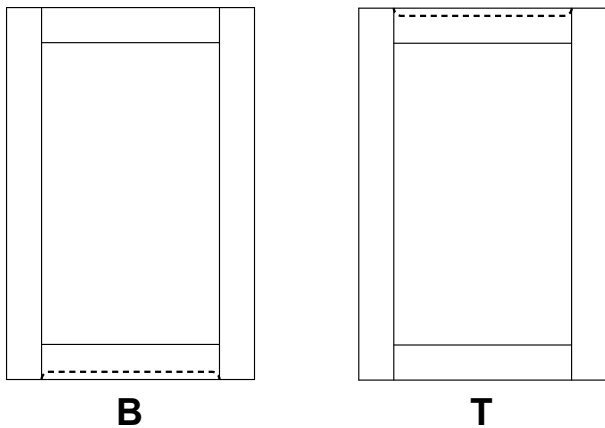

Please use abbreviations below and enter in the special notes column on order form to specify placement of full length fingerpulls.
All pulls are viewed from the face of doors and drawer fronts.

Top	T
Bottom	B
Right	R
Left	L

Minimum Door Height and Width for fingerpulls is 6 ½" x 6 ½".

Fingerpulls are available on all edges except 814, 817, 839, 841, 845, 846, 859, 892, 894 and all 8000 series edges.

Pair Doors

Call Customer Service for Current Pricing

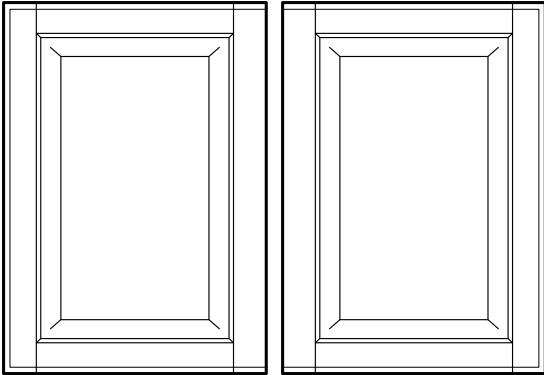

Add \$x.xx per door for pair doors.

Westwind gives you the option to leave one edge of the door square while edging the other three. When ordering pair doors, the edge that is to be left square must be specified: Left (NELS), Right (NERS), or Pair (PR). These codes should be used in the special notes column on the order form.

Lazy Susan Options

Call Customer Service for Current Pricing

Lazy Susan Butt Joint

Add \$x.xx per wide stile & \$x.xx per butt joint.

On Lazy Susan Butt Doors, we recommend that one door have a $\frac{3}{4}$ " wider stile than the specified frame size to make them look symmetrical when they are fastened together.

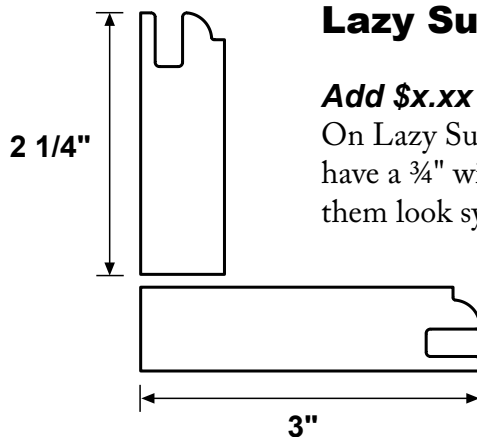

Lazy Susan Miter Joint

Add \$x.xx per wide stile & \$x.xx per miter joint.

On Lazy Susan Miter Doors, we recommend that both doors have a $\frac{3}{4}$ " wider stile to make them look symmetrical when they are fastened together.

